

DESCRIPTION

2SC2053 is a silicon NPN epitaxial planar type transistor designed for RF amplifiers on VHF band mobile radio applications.

FEATURES

- High power gain: $G_{pe} \geq 15.7\text{dB}$
@ $V_{CC} = 13.5\text{V}$, $P_O = 0.15\text{W}$, $f = 175\text{MHz}$
- Emitter ballasted construction, gold metallization for high reliability and good performances.
- TO-92 similar package is combinient for mounting.

APPLICATION

Driver amplifiers in general in VHF band mobile radio applications.

OUTLINE DRAWING

Dimensions in mm

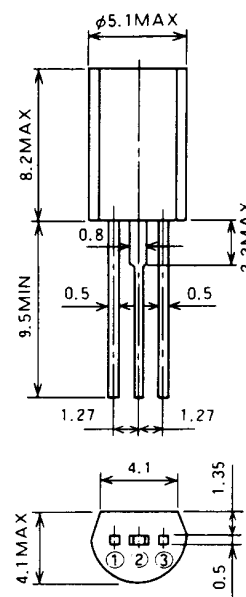

PIN :
① BASE
② COLLECTOR
③ EMITTER

TO-92L

ABSOLUTE MAXIMUM RATINGS ($T_C = 25^\circ\text{C}$ unless otherwise specified)

Symbol	Parameter	Conditions	Ratings	Unit
V_{CBO}	Collector to base voltage		40	V
V_{EBO}	Emitter to base voltage		4	V
V_{CEO}	Collector to emitter voltage	$R_{BE} = \infty$	17	V
I_C	Collector current		0.3	A
P_C	Collector dissipation	$T_a = 25^\circ\text{C}$	0.6	W
T_j	Junction temperature		135	$^\circ\text{C}$
T_{stg}	Storage temperature		-55 to 135	$^\circ\text{C}$
R_{th-a}	Thermal resistance	Junction to ambient	183	$^\circ\text{C/W}$

Note. Above parameters are guaranteed independently.

ELECTRICAL CHARACTERISTICS ($T_C = 25^\circ\text{C}$ unless otherwise specified)

Symbol	Parameter	Test conditions	Limits			Unit
			Min	Typ	Max	
$V_{(BR)EBO}$	Emitter to base breakdown voltage	$I_E = 1\text{mA}$, $I_C = 0$	4			V
$V_{(BR)CBO}$	Collector to base breakdown voltage	$I_C = 1\text{mA}$, $I_E = 0$	40			V
$V_{(BR)CEO}$	Collector to emitter breakdown voltage	$I_C = 10\text{mA}$, $R_{BE} = \infty$	17			V
I_{CBO}	Collector cutoff current	$V_{CB} = 15\text{V}$, $I_E = 0$			20	μA
I_{EBO}	Emitter cutoff current	$V_{EB} = 3\text{V}$, $I_C = 0$			20	μA
h_{FE}	DC forward current gain*	$V_{CE} = 10\text{V}$, $I_C = 10\text{mA}$	10	50	180	—
P_O	Output power	$V_{CC} = 13.5\text{V}$, $P_{in} = 4\text{mW}$, $f = 175\text{MHz}$	150	200		mW
η_C	Collector efficiency		40	50		%

Note. *Pulse test, $P_w = 150\mu\text{s}$, duty=5%.

Above parameters, ratings, limits and conditions are subject to change.

TEST CIRCUIT

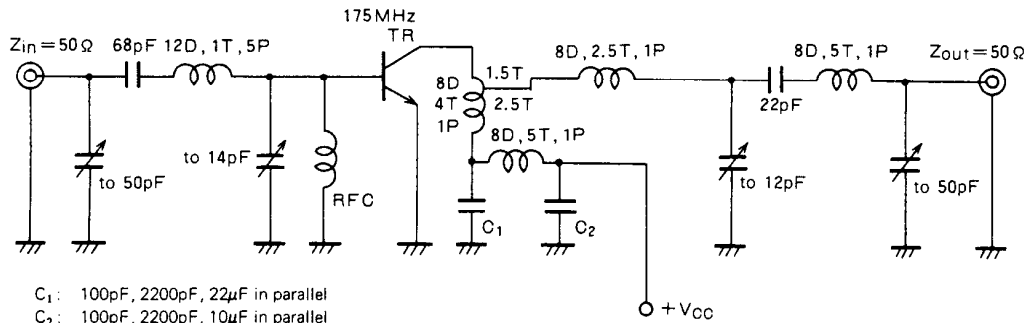

C_1 : 100pF, 2200pF, 22 μ F in parallel
 C_2 : 100pF, 2200pF, 10 μ F in parallel
 Notes: All coils are made from 1.5mm ϕ silver plated copper wire
 Coil dimensions in milli-meter
 D: Inner diameter of coil
 T: Turn number of coil
 P: Pitch of coil

TYPICAL PERFORMANCE DATA

COLLECTOR DISSIPATION VS. AMBIENT TEMPERATURE

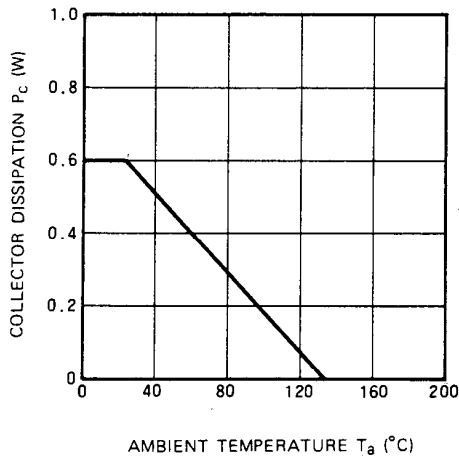

COLLECTOR CURRENT VS. COLLECTOR TO EMITTER VOLTAGE

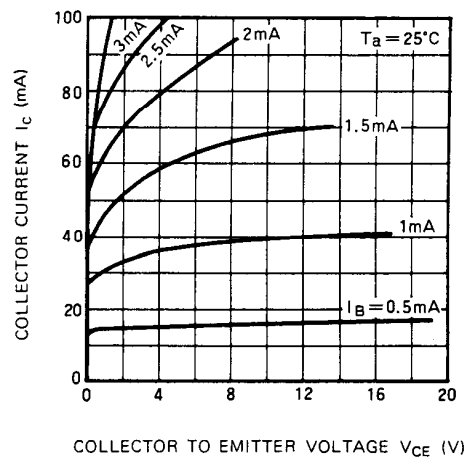

COLLECTOR TO EMITTER BREAKDOWN VOLTAGE VS. BASE TO EMITTER RESISTANCE

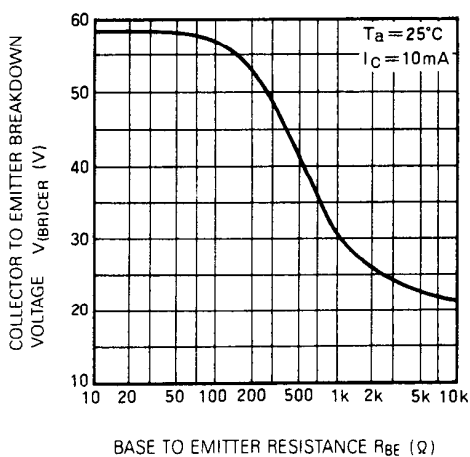

DC CURRENT GAIN VS. COLLECTOR CURRENT

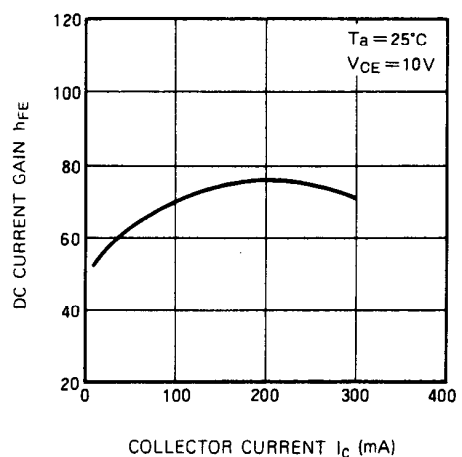

NPN EPITAXIAL PLANAR TYPE

COLLECTOR OUTPUT CAPACITANCE VS. COLLECTOR TO BASE VOLTAGE

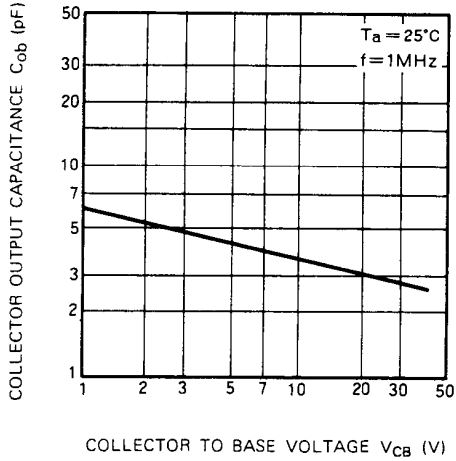

OUTPUT POWER, COLLECTOR EFFICIENCY VS. INPUT POWER

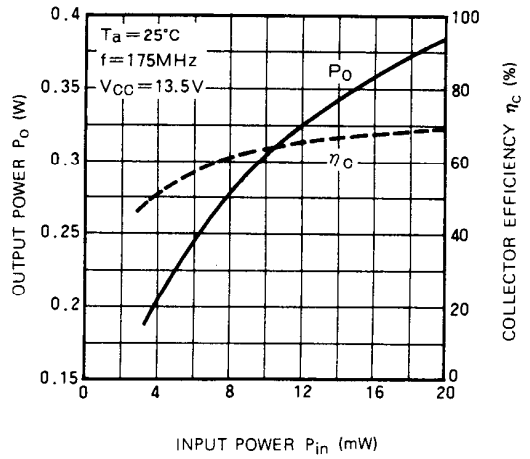

OUTPUT POWER VS. COLLECTOR SUPPLY VOLTAGE

